

MADE IN THE USA

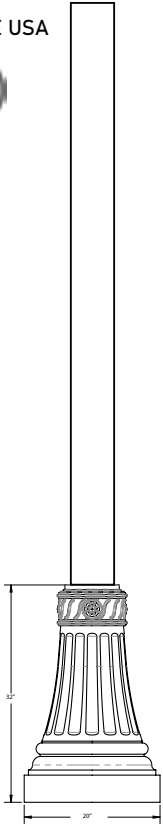

CS-BC-101-2032-SB



Housing:
1 piece structural base,
cast aluminum

Ordering Information:

	W	H
(4" dia. pole)	20"	32"
(5" dia. pole)	20"	32"
(6" dia. pole)	20"	32"
(7" dia. pole)	20"	32"
(8" dia. pole)	20"	32"

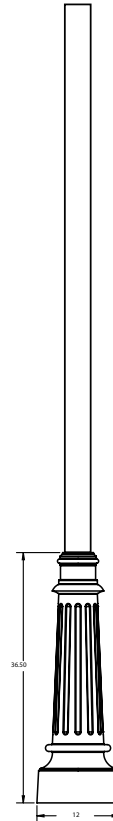

CS-BC-102-1236-SB



Housing:
1 piece structural
base, cast aluminum

Ordering Information:

	W	H
(4" dia. pole)	12"	36"
(5" dia. pole)	12"	36"

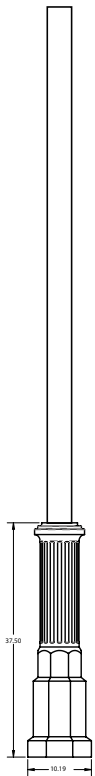

CS-BC-103-1037-SB



Housing:
1 piece structural
base, cast aluminum

Ordering Information:

	W	H
(4" dia. pole)	10"	37"
(5" dia. pole)	10"	37"

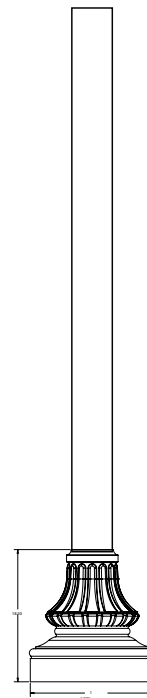

CS-BC-104-1618-SB



Housing:
1 piece structural
base, cast aluminum

Ordering Information:

	W	H
(4" dia. pole)	16"	18"
(5" dia. pole)	16"	18"



AMERICAN COMBAT VETERAN OWNED COMPANY



405-673-8684

www.gridshiftsolar.lighting

Corporate: 2803 Broadway Ct. Edmond, OK 73013
California: 1341 Distribution Way, Suite 20, Vista, CA 92081

Cuesta Sol is a trademark of GridShift Solutions, LLP



MADE IN THE USA



CS-BC-105-1818



Housing:

2 piece clam shell base, cast aluminum

Ordering Information:

	W	H
(4" dia. pole)	18"	18"
(5" dia. pole)	18"	18"

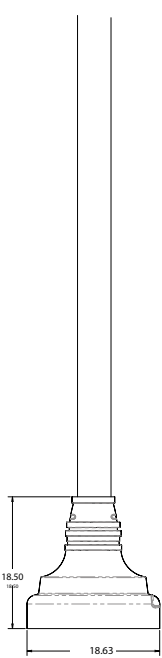

CS-BC-106-1842



Housing:

2 piece clam shell base, cast aluminum

Ordering Information:

	W	H
(4" dia. pole)	18"	42"
(5" dia. pole)	18"	42"
(6" dia. pole)	18"	42"

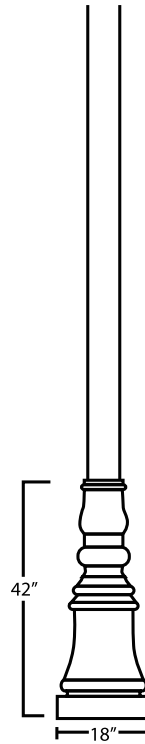

CS-BC-107-1842



Housing:

2 piece clam shell base, cast aluminum

Ordering Information:

	W	H
(4" dia. pole)	18"	42"
(5" dia. pole)	18"	42"

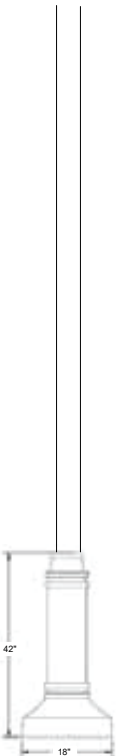

CS-BC-108-1836-SB



Housing:

1 piece structural base, cast aluminum

Ordering Information:

	W	H
(4" dia. pole)	18"	36"
(5" dia. pole)	18"	36"

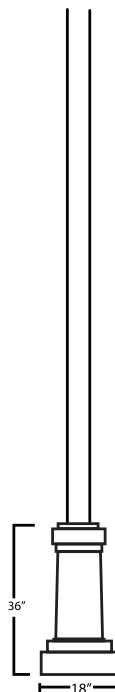

AMERICAN COMBAT VETERAN OWNED COMPANY



405-673-8684

www.gridshiftsolar.lighting

Corporate: 2803 Broadway Ct. Edmond, OK 73013
California: 1341 Distribution Way, Suite 20, Vista, CA 92081

Cuesta Sol is a trademark of GridShift Solutions, LLP



MADE IN THE USA



CS-BC-109-1524

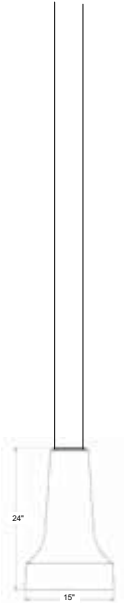

Housing:
2 piece clam shell base, cast aluminum

Ordering Information:

	W	H
(4" dia. pole)	15"	24"
(5" dia. pole)	15"	24"

CS-BC-110-1817

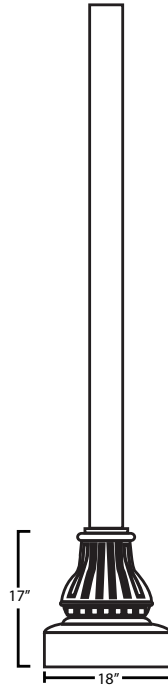

Housing:
2 piece clam shell base, cast aluminum

Ordering Information:

	W	H
(4" dia. pole)	18"	17"
(5" dia. pole)	18"	17"

CS-BC-111-SB

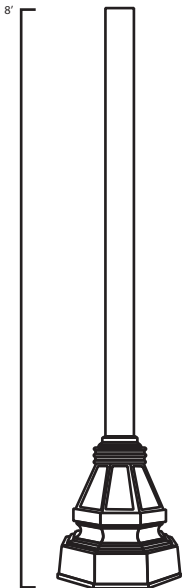

Housing:
2 piece clam shell base, cast aluminum

Ordering Information:

	W	H
(4" dia. pole)	25"	24"
(5" dia. pole)	25"	24"
(6" dia. pole)	25"	24"

CS-BC-111-SB

CS-BC-112-1609
CS-BC-112-1810

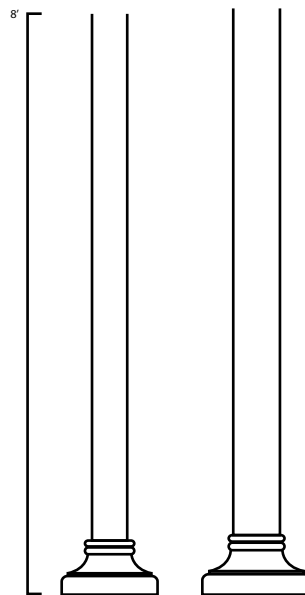

Housing:
1 piece structural base, cast aluminum

Ordering Information:

	W	H
(5" dia. pole)	16"	9"
(6" dia. pole)	18"	10"

CS-BC-112-1609

CS-BC-112-1810



AMERICAN COMBAT VETERAN OWNED COMPANY



405-673-8684

www.gridshiftsolar.lighting

Corporate: 2803 Broadway Ct. Edmond, OK 73013
California: 1341 Distribution Way, Suite 20, Vista, CA 92081

Cuesta Sol is a trademark of GridShift Solutions, LLP



MADE IN THE USA



CS-BC-113-SB

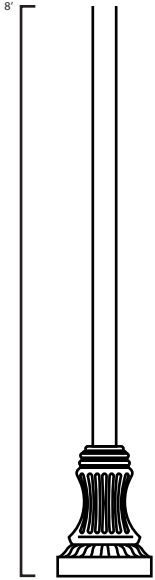

Housing:
1 piece structural base, cast aluminum

Ordering Information:

	W	H
(4" dia. pole)	16"	22"

CS-BC-114-1023

CS-BC-114-1024

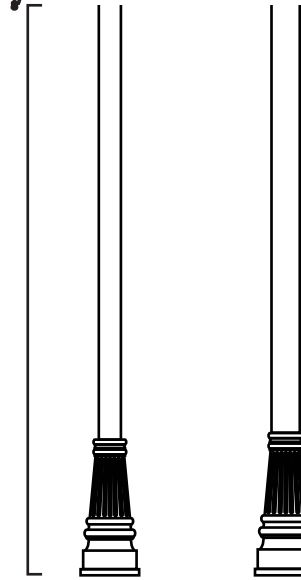

Housing:
2 piece clam shell base, cast aluminum

Ordering Information:

	W	H
(4" dia. pole)	10"	23"
(5" dia. pole)	10½"	24"

CS-BC-114-1023

CS-BC-114-1024

CS-BC-115-1650

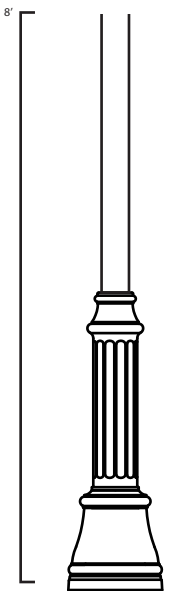

Housing:
2 piece clam shell base, cast aluminum

Ordering Information:

	W	H
(5" dia. pole)	16"	50"
(6" dia. pole)	16"	50"

CS-BC-115-1650

CS-BC-116-SB-1118

CS-BC-116-SB-2032

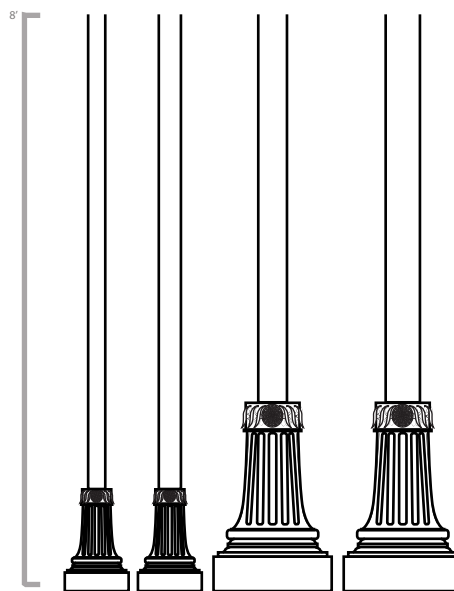

Housing:
1 piece structural base, cast aluminum

Ordering Information:

	W	H
(3" dia. pole)	11"	18"
(4" dia. pole)	11"	18"
(5" dia. pole)	20"	32"
(6" dia. pole)	20"	32"

CS-BC-116-SB-1118

CS-BC-116-SB-2032



AMERICAN COMBAT VETERAN OWNED COMPANY



405-673-8684

www.gridshiftsolar.lighting

Corporate: 2803 Broadway Ct. Edmond, OK 73013
California: 1341 Distribution Way, Suite 20, Vista, CA 92081

Cuesta Sol is a trademark of GridShift Solutions, LLP



MADE IN THE USA



CS-BC-117-1736

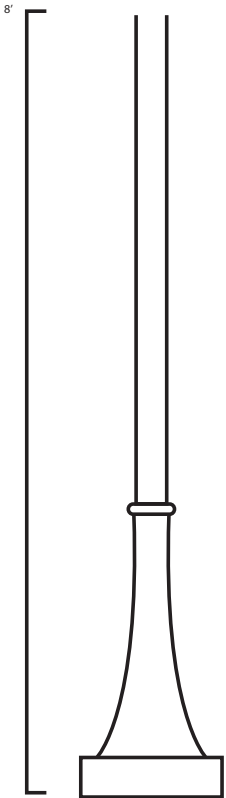

Housing:
2 piece clam shell base, cast aluminum

Ordering Information:

	W	H
(4" dia. pole)	17 1/2"	36"

CS-BC-118-2554

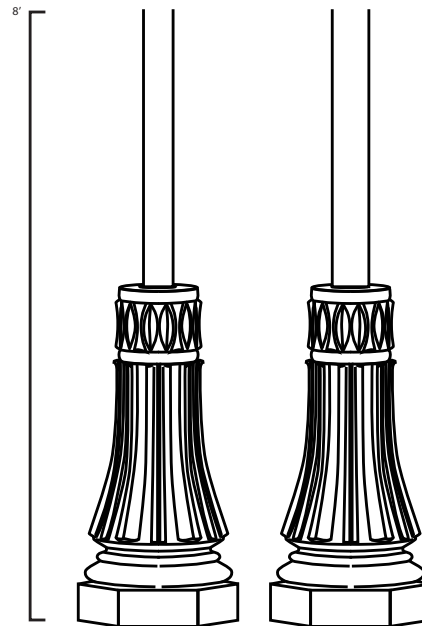

Housing:
2 piece clam shell base, cast aluminum

Ordering Information:

	W	H
(5" dia. pole)	25"	54"
(6" dia. pole)	25"	54"



AMERICAN COMBAT VETERAN OWNED COMPANY



405-673-8684

www.gridshiftsolar.lighting

Corporate: 2803 Broadway Ct. Edmond, OK 73013
California: 1341 Distribution Way, Suite 20, Vista, CA 92081

Cuesta Sol is a trademark of GridShift Solutions, LLP



Wounded Warrior Project

MADE IN THE USA

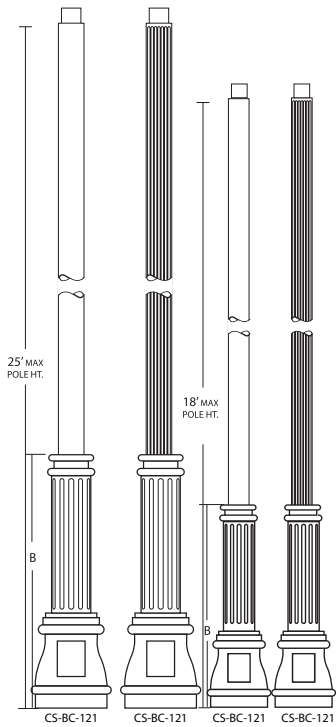

CS-BC-121

Construction:
Durable corrosion resistant, cast aluminum base with hand hole and cover. The pole shall be 4" dia. x 3/16" wall thickness, extruded 6063-T6 aluminum alloy

Anchor Bolts:
(4) 3/4" x 16" x 3"
Fabricated from hot rolled steel.
Hot dip galvanized.

Finish:
Polyester powder fuse coating.
BK- Black
BZ- Bronze
GN- Green
VG- Verde Green
(for other colors, consult factory)

Ordering Information:

1. Model Number
2. Pole Ht
3. Finish
4. Options
DR- Duplex Receptacle
GFI- Ground Fault Interruptor

Pole Ht	A	B	BC
25' MAX	16"	50"	10"
16' MAX	11.5"	41"	8"

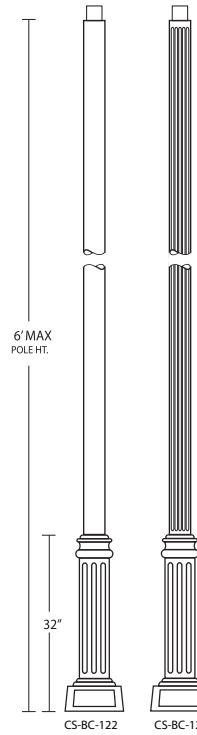
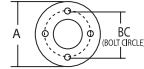

CS-BC-122

Construction:
Durable corrosion resistant, cast aluminum base with hand hole and cover. The pole shall be 4" dia. x 3/16" wall thickness, extruded 6063-T6 aluminum alloy

Anchor Bolts:
(4) 3/4" x 16" x 3"
Fabricated from hot rolled steel.
Hot dip galvanized.

Finish:
Polyester powder fuse coating.
BK- Black
BZ- Bronze
GN- Green
VG- Verde Green
(for other colors, consult factory)

Ordering Information:

1. Model Number
2. Pole Ht
3. Finish
4. Options
DR- Duplex Receptacle
GFI- Ground Fault Interruptor

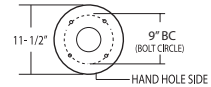

CS-BC-123-SB

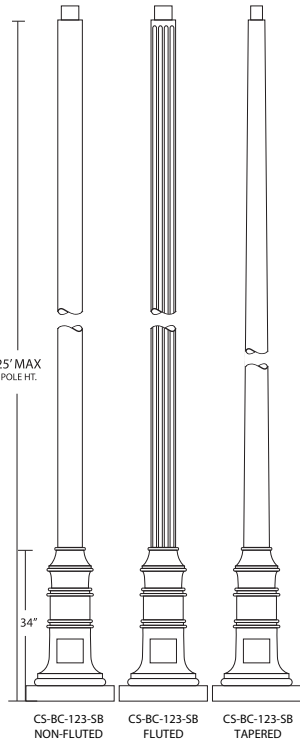

Construction:
Durable corrosion resistant, cast aluminum base with hand hole and cover. The pole shall be 4" dia. x 3/16" wall thickness, extruded 6063-T6 aluminum alloy

Anchor Bolts:
(4) 3/4" x 16" x 3" up to 18 and
(4) 3/4" x 24" x 3" for 20'
Fabricated from hot rolled steel.
Hot dip galvanized.

Finish:
Polyester powder fuse coating.
BK- Black
BZ- Bronze
GN- Green
VG- Verde Green
(for other colors, consult factory)

Ordering Information:

1. Model Number
2. Pole Ht
3. Finish
4. Options
DR- Duplex Receptacle
GFI- Ground Fault Interruptor

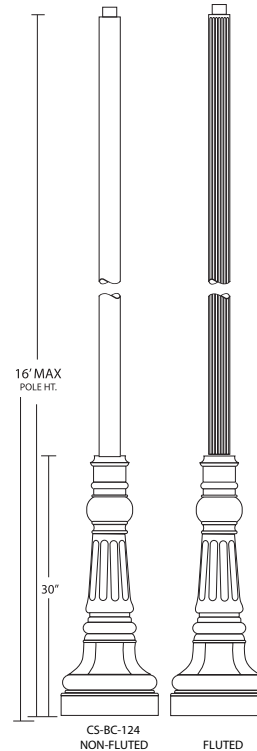
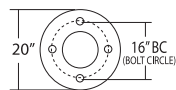

CS-BC-124

Construction:
Durable corrosion resistant, cast aluminum base with hand hole and cover. The pole shall be 4" dia. x 3/16" wall thickness, extruded 6063-T6 aluminum alloy

Anchor Bolts:
(4) 3/4" x 16" x 3"
Fabricated from hot rolled steel.
Hot dip galvanized.

Finish:
Polyester powder fuse coating.
BK- Black
BZ- Bronze
GN- Green
VG- Verde Green
(for other colors, consult factory)

Ordering Information:

1. Model Number
2. Pole Ht
3. Finish
4. Options
DR- Duplex Receptacle
GFI- Ground Fault Interruptor

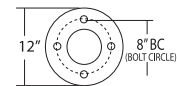

AMERICAN COMBAT VETERAN OWNED COMPANY



405-673-8684

www.gridshiftsolar.lighting

Corporate: 2803 Broadway Ct. Edmond, OK 73013
California: 1341 Distribution Way, Suite 20, Vista, CA 92081

Cuesta Sol is a trademark of GridShift Solutions, LLP

