

Specification Highlights

- MADE IN USA
- 25" x 29" solar panel-70 Watt monocrystalline
- 48 AH 12.8V Lithium Iron Phosphate Battery
- Philips Lumileds 5050 LED
- 5 Year Standard Warranty
- Burn Time Certified
- Core Restore battery recycling included
- Wildlife/Turtle friendly amber CCT available

All in One Design

- Solar panel, battery & controller in one attractive luminaire
- No visible solar panel or battery box
- Low EPA for less strain on pole and lower install costs
- Easy retro-fit to existing poles



10 Year Available
15 Year Available



OPTIONS
Motion Sensor & Light Shield



Exclusive Free
Battery Recycling
Program

Available with:



5G Remote Access

- Monitor
- Set Timing
- Get Alerts



Certifications



Components

Model #	Solar Panel Wattage	Battery	Charge Time (In Hours)		BUG Rating
CS-SIE-2529-15W	70	48AH 12.8V	8	40 hrs	B1-U0-G1
CS-SIE-2529-20W	70	48AH 12.8V	8	30 hrs	B1-U0-G1
CS-SIE-2529-25W	70	48AH 12.8V	8	26 hrs	B1-U0-G1
CS-SIE-2529-30W	70	48AH 12.8V	8	22 hrs	B1-U0-G1
CS-SIE-2529-35W	70	48AH 12.8V	8	20 hrs	B1-U0-G1

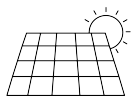

Monocrystalline
Solar Module

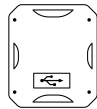

Self Learning
Controller



LiFePO4
Lithium-Iron
Battery

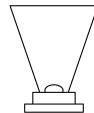

Philips Lumileds
Luxeon 5050
Chip

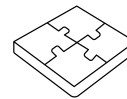

All-in-One



Optional
Motion Sensor



AMERICAN COMBAT VETERAN OWNED COMPANY



405-673-8684

www.gridshiftsolar.lighting

Corporate: 2803 Broadway Ct. Edmond, OK 73013
California: 1341 Distribution Way, Suite 20, Vista, CA 92081

Cuesta Sol is a trademark of GridShift Solutions, LLP

GRIDSHIFT™
SOLAR LIGHTING



Wounded Warrior Project



Photometrics

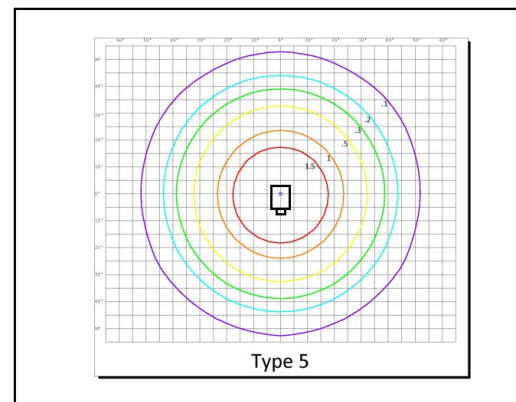
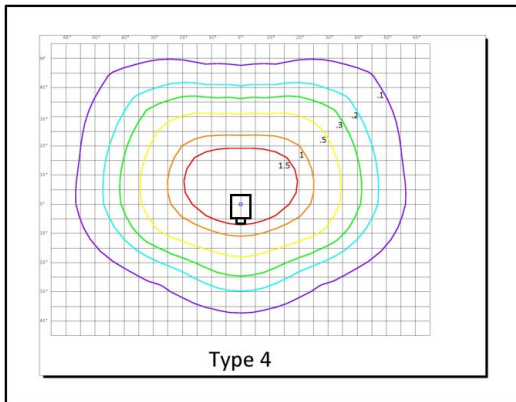
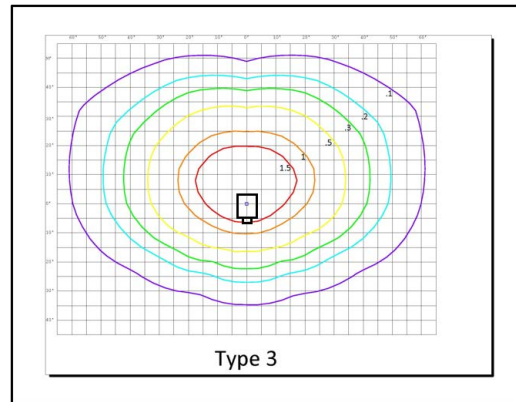
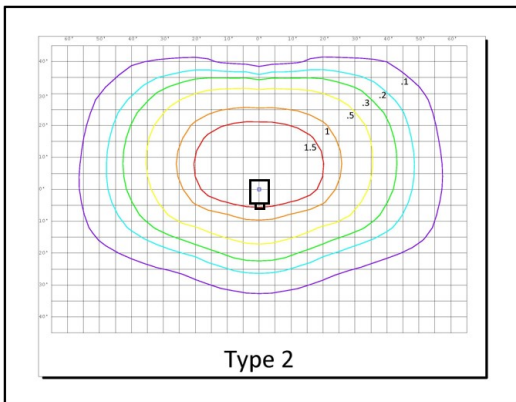

*Please note, for pattern reference only. Model shown is 30W at 20' mounted height. Email for current IES files.



AMERICAN COMBAT VETERAN OWNED COMPANY



405-673-8684
www.gridshiftsolar.lighting

Corporate: 2803 Broadway Ct. Edmond, OK 73013
 California: 1341 Distribution Way, Suite 20, Vista, CA 92081

Cuesta Sol is a trademark of GridShift Solutions, LLP





CS-SIE-2529-1



CS-SIE-2529-2

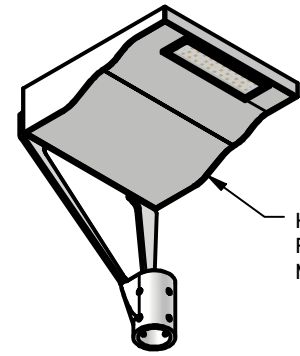

HINGED DOOR FOR EASY MAINTENANCE

CS-SIE-2529-3

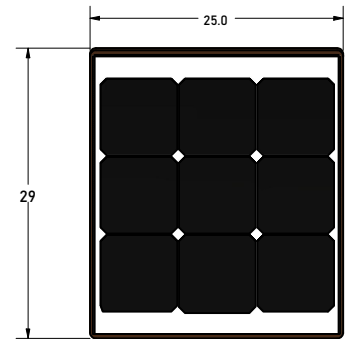
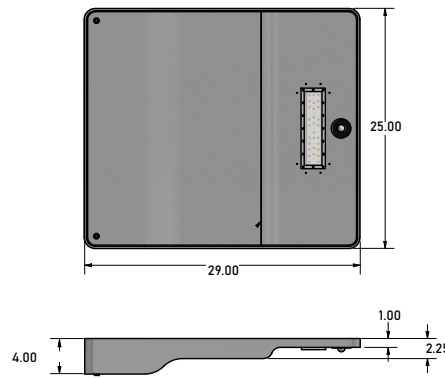
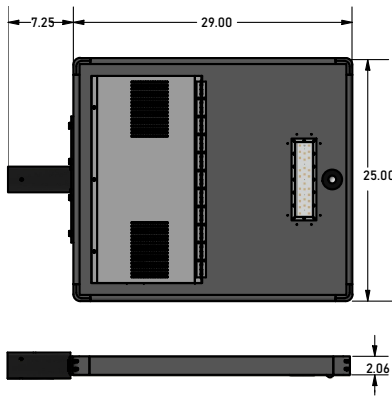

Comes with external SS mounting bracket

EPA: .54 Comes with internal mounting system with 2.5" dia. x 7" deep opening

Comes with 2.5" OD X 3" tall Post Top Mounting Provision that fits 2.375" O.D. X 3" tall Tenon

Weight: 37.5lbs
EPA: .48

*Custom mounting systems available upon request. Consult with factory for details.

Model #	Watts	Lumens	Available Optic Types	Color Temp in 100K	Fixture Profile Codes	Mounting Bracket Option (See Bracket Codes)	Color (BLK-Black/BRZ-Bronze/GRY-Grey/CUST-Custom)	Optional 5G Remote Access (Yes/No)	Style (see above)
Cuesta Sol CS-SIE-2529	15	2700	II / III / IV / V	30K / 40K / 50K / 57K / 65K	(See Profile Codes)	MB-1 / MB-2 / MB-3...	BLK / BRZ / GRY / CUS	Y / N	1/2/3
Cuesta Sol CS-SIE-2529	20	3600	II / III / IV / V	30K / 40K / 50K / 57K / 65K	(See Profile Codes)	MB-1 / MB-2 / MB-3...	BLK / BRZ / GRY / CUS	Y / N	1/2/3
Cuesta Sol CS-SIE-2529	25	4500	II / III / IV / V	30K / 40K / 50K / 57K / 65K	(See Profile Codes)	MB-1 / MB-2 / MB-3...	BLK / BRZ / GRY / CUS	Y / N	1/2/3
Cuesta Sol CS-SIE-2529	30	5400	II / III / IV / V	30K / 40K / 50K / 57K / 65K	(See Profile Codes)	MB-1 / MB-2 / MB-3...	BLK / BRZ / GRY / CUS	Y / N	1/2/3
Cuesta Sol CS-SIE-2529	35	6300	II / III / IV / V	30K / 40K / 50K / 57K / 65K	(See Profile Codes)	MB-1 / MB-2 / MB-3...	BLK / BRZ / GRY / CUS	Y / N	1/2/3

Ordering Description Example

Cuesta Sol CS-SIE-2529	15	2700	III	30K	A	MB-1	BLK	Y	1
------------------------	----	------	-----	-----	---	------	-----	---	---

Ordering Description

Model #	Watts	Lumens	Available Optic Types	Color Temp in 100K	Fixture Profile Codes	Mounting Bracket Option	Color	Optional 5G Remote Access	Style
Cuesta Sol CS-SIE-2529	15	2700							
Cuesta Sol CS-SIE-2529	20	3600							
Cuesta Sol CS-SIE-2529	25	4500							
Cuesta Sol CS-SIE-2529	30	5400							
Cuesta Sol CS-SIE-2529	35	6300							



Standard Profile

- a. On at dusk 100% to dawn.
- b. SMART controller prevents "dark" nights by adjusting to use available power.

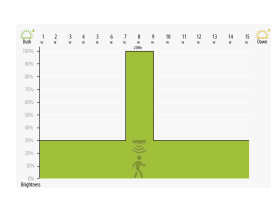

AMERICAN COMBAT VETERAN OWNED COMPANY



405-673-8684

www.gridshiftsolar.lighting

Corporate: 2803 Broadway Ct. Edmond, OK 73013
California: 1341 Distribution Way, Suite 20, Vista, CA 92081

Cuesta Sol is a trademark of GridShift Solutions, LLP



Wounded Warrior Project

Solar Panel



High Efficiency Mono-Crystalline Module

18.5% photoelectric Conversion Efficiency
Ending with 85% output in 20 years
3.2mm tempered glass lamination for excellent
mechanical load resistance.

Lithium Iron Battery

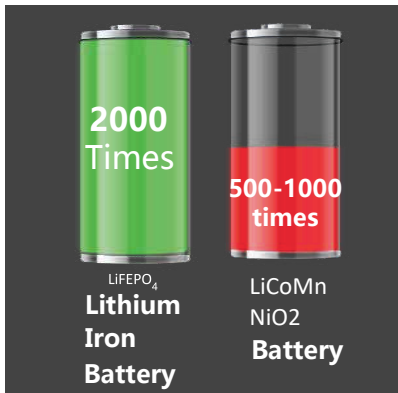

Lithium Iron Phosphate Battery (LiFe P04)

This integrated solar street lamp series uses high-efficiency lithium iron phosphate battery, high temperature performance, high current discharge, and has a cycle life of more than 2000 times.

Led Chip

LUMILEDS



LUXEON 5050

Philips Lumileds Luxeon 5050 Chip

By using the Philips luxeon LED chips, our single lumen value is 180Lm/w. It has excellent heat dissipation and maintains high levels of brightness with little fading. The sealed lenses are made with strong UV protected PC and have anti-aging and shock resistant values. The well optimized light distribution makes for a uniform photometric footprint.

Burn Time

Burn Time Certification



Burn Time Testing works in conjunction with ASTM standards to evaluate and validate the solar luminaire's performance in a controlled environment based on your required lighting profile. This testing also equalizes the environment, tests the products performance, and provides reliable results that can be compared without subjectivity. Burn Time Testing ensures that the product being considered has undergone stringent, objective, 3rd party testing



AMERICAN COMBAT VETERAN OWNED COMPANY



405-673-8684

www.gridshiftsolar.lighting

Corporate: 2803 Broadway Ct. Edmond, OK 73013
California: 1341 Distribution Way, Suite 20, Vista, CA 92081

Cuesta Sol is a trademark of GridShift Solutions, LLP

GRIDSHIFT[™]
SOLAR LIGHTING



Wounded Warrior Project